

RADIATION ALERT®

Inspector & **Inspector EXP**

User Manual

Hubungi Kami Agen Penjualan di Indonesia:

 **PT. BJW GLOBAL RADIUSINDO**

Alamat: Batan Indah Blok M-27, Desa/Kelurahan
Kademangan, Kec. Setu, Kota Tangerang Selatan,
Provinsi Banten, Kode Pos: 15313.

Website: www.bjwglobal.co.id

Email: admin@bjwglobal.co.id

HP/WA: Wulan Purbowati (081808126327)



INSPECTOR User Manual - Contents

Chapter		Page
1	Introduction	4
	How the Inspector Detects Radiation	4
	Precautions	4
2	Features	5
	The Display	6
	The Switches	7
	The Detector	8
	The Input/Output Ports	9
3	Operation	10
	Units of Measurement	10
	Starting the Inspector	10
	Start Up	10
	Display Update	10
	Maximum Level	10
	Response Time (Autoaveraging)	11
	Operating in Dose Rate Modes	11
	Operating in Total/Timer Mode	12
	Taking a Timed Count	12
	Using Dose Rates While Timer is On	13
	Taking a Total Count	13
	Autoranging	13
	Utility Menu	14
	Interfacing to an External Device	15
	Options	15
	WipeTest Plate	15

04/03/00

4	Common Procedures	15
	Establishing the Background Count	15
	Environmental Area Monitoring	16
	Checking for Surface Contamination	16
5	Maintenance	17
	Calibration	17
	Troubleshooting	20
	Service	21
6	Basics of Radiation and Its Measurement	21
	Ionizing Radiation	22
	Chart of Radionuclides	23
	Radiation Measurement Units	23
	Appendix A Technical Specifications	24
	Appendix B Sensitivity to Common Isotopes	25
	Appendix C Inspector EXP carrying case	26
	Warranty	28
	Calibration Data Base Application	29

List of Illustrations

Illustration 1	Front View	5
Illustration 2	End Panel View	6
Illustration 3	Display	6
Illustration 4	Rear View (Detector)	9

04/03/00

1 Introduction

The Inspector is a health and safety instrument that is optimized to detect low levels of radiation. It measures alpha, beta, gamma, and x-ray radiation.

Its applications include:

- Detecting and measuring surface contamination
- Monitoring possible radiation exposure while working with radionuclides
- Screening for environmental contamination
- Detecting noble gases and other low energy radionuclides

How the Inspector Detects Radiation

The Inspector uses a Geiger-Mueller tube to detect radiation. The Geiger tube generates a pulse of electrical current each time radiation passes through the tube and causes ionization. Each pulse is electronically detected and registers as a count. The Inspector displays the counts in the mode you choose.

The number of counts detected by the Inspector varies from minute to minute due to the random nature of radioactivity. A reading is expressed more accurately as an average over time, and the average is more accurate over a longer time period. For details, see "Operating in Total/Timer Mode" in Chapter 3.

Precautions

To keep the Inspector in good condition, handle it with care, and observe the following precautions:

- Do not contaminate the Inspector by touching it to radioactive surfaces or materials. If contamination is suspected, replacement rubber strips are stapled inside this manual.
- Do not leave the Inspector in temperatures over 100° F (38° C) or in direct sunlight for extended periods of time.
- Do not get the Inspector wet. Water can damage the circuitry and the mica surface of the Geiger tube.
- Do not put the Inspector in a microwave oven. It cannot measure microwaves, and you may damage it or the oven.

- This instrument may be sensitive to and may not operate properly in radio frequency, microwave, electrostatic, and electromagnetic fields.
- If you expect to not use the Inspector for longer than one month, remove the battery to avoid damage from battery corrosion.
- Change the battery promptly when the battery indicator appears on the display.

2 Features

The Inspector measures alpha, beta, gamma, and x-ray radiation. It is optimized to detect small changes in radiation levels and to have high sensitivity to many common radionuclides. For more information, see Appendix A, "Sensitivity to Common Radionuclides."

This chapter briefly describes the Inspector's functions. For more information on how to use the Inspector, see Chapter 3, "Operation."

The Inspector counts ionizing events and displays the results on the liquid crystal display (LCD). You control which unit of measurement is shown by using the mode switch.

Whenever the Inspector is operating, the red **count light (8)** flashes each time a count (an ionizing event) is detected.

Illustration 1 Front View

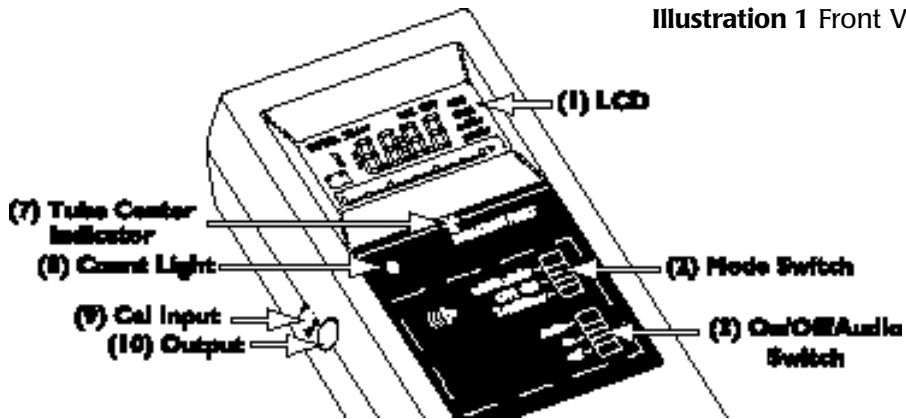

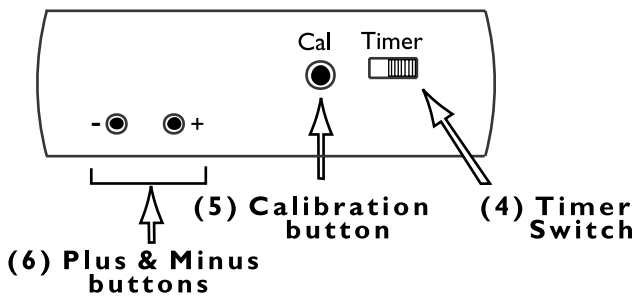

Illustration 2 End Panel View

The Display (1)

The LCD (liquid crystal display) shows various indicators according to the mode setting, function being performed, and battery condition.

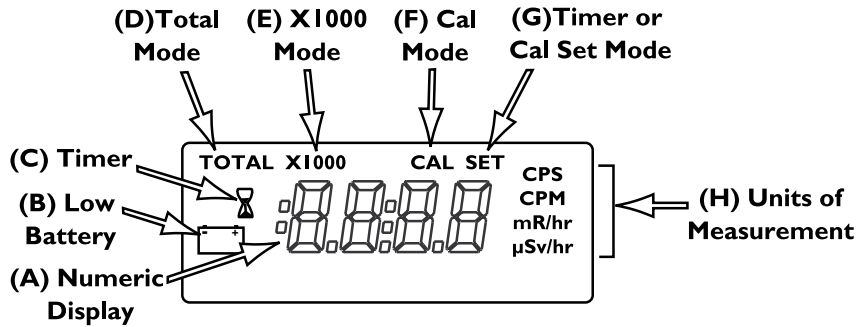

Illustration 3 Display Indicators

INDICATORS:

- The **numeric display (A)** shows the current radiation level in the unit specified by the mode switch setting.
- A small **battery (B)** appears to the left of the numeric display indicating low battery voltage.
- An **hourglass (C)** appears to the left of the numeric display while in the Cal mode or during a timed count.

- **TOTAL (D)** appears when the Inspector is in Total/Timer mode.
- **X1000 (E)** appears when the numeric display is to be multiplied by 1000.
- **CAL (F)** is shown while you are calibrating the Inspector.
- **SET (G)** appears when you are setting the timer (the numeric display shows the timed period instead of the current radiation level), and in the Cal mode (the numeric display shows the Cal factor instead of the current radiation level).
- The current **unit of measurement (H)**—**CPM, CPS, mR/hr or μ Sv/hr**—is displayed to the right of the numeric display.

The Switches

The Inspector has two switches on the front, and one switch and three buttons on the end panel. Each switch has three settings which are described below.

Mode Switch (2)

mR/hr μ Sv/hr. The numeric display shows the current radiation level in milliroentgens per hour or, when SI units are used, in microsieverts per hour.

In mR/hr mode, the Inspector displays the radiation level from .001 to 100.

In μ Sv/hr mode, the Inspector displays the radiation level from .01 to 1000.

See “Utility Menu” in Chapter 3 for details on how to activate this mode.

CPM CPS. In CPM, the display shows the current radiation level in counts per minute from 0 to 300,000. When **X1000** is shown on the display, multiply the numeric reading by 1000 to get the complete radiation level. When using SI units, the display shows the radiation level in counts per second from 0 to 5000.

Total/Timer. The display shows the accumulated total of counts from 1 to 9,999,000. When **X1000** is shown on the display, multiply the numeric reading by 1000 to get the complete radiation level. Totaling starts when the switch is moved to this position. For details, see “Taking a Timed or Total Count” in Chapter 3.

Off/On/Audio Switch (3)

Audio. The Inspector is on and makes a clicking sound for each radiation event detected.

On. The Inspector is operating, but audio is off.

Off. The Inspector is not operating.

+ and - Buttons (6)

The + and - buttons are used to adjust the numeric display for timed counts and during calibration. See “Taking a Timed Count” in Chapter 3 and “Calibration” in Chapter 5.

The + and - buttons can also be used to make selections in the “Utility Menu”. For details, see “Utility Menu” in Chapter 3.

Timer Switch (4)

Off. The timer is not operating.

Set. The length of the timed period can now be set using the + and - buttons. If the timer is already operating, the display shows the time remaining in the timed period.

On. The timer is operating, and the display shows the total counts accumulated so far in the timed period.

CAL Button (5)

The CAL button is used to perform calibration on the Inspector. See “Calibration” in Chapter 5 for more information.

The CAL button is also used to make selections in the “Utility Menu”. See Chapter 3.

The Detector

CAUTION: *The mica surface of the Geiger tube is fragile. Be careful not to let anything penetrate the screen.*

Internal- For Inspector only

The Inspector uses a two-inch Geiger tube, commonly called a “pancake tube.” On the back of the Inspector, the screen is called the window. See illustration 4. It allows alpha and low-energy beta and gamma radiation, which cannot get through the plastic case, to penetrate the mica surface of the tube. The small **radiation symbol (7)** on the front label indicates the center of the Geiger tube.

External - For Inspector EXP only

The Inspector EXP has an external pancake probe instead of the built-in detector.

To connect the detector, plug one end of the cable into the connector on the end of the Inspector and the other end to the probe. **Caution:** *The connectors are directional. Be sure to line them up properly before trying to fit them together. If the probe is not connected, the instrument will not function properly.*

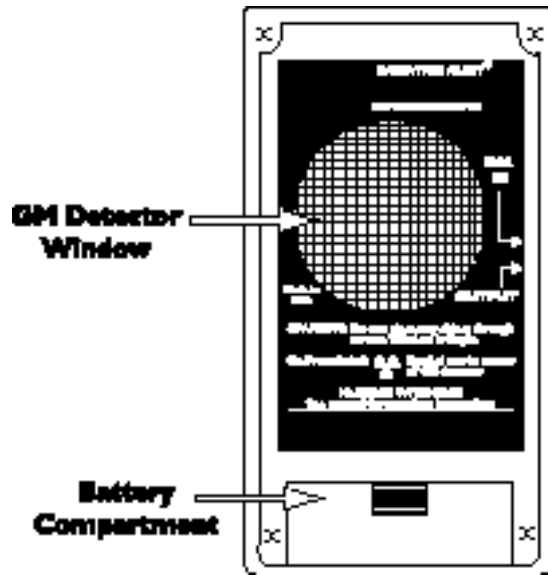

Illustration 4 Inspector Rear View (Detector)

The Input/Output Ports

There are two ports on the left side of the Inspector. Certain models have a third port on the end panel.

The **Cal Input (9)** port is used for calibrating electronically using a pulse generator. For details, see “Calibrating Electronically” in Chapter 5.

The **Output (10)** port below the Cal Input jack allows you to interface the Inspector to a computer, data logger, or other device. For details, see “Interfacing

to an External Device” in Chapter 3.

Optional probe port. The optional probe port on the end panel (present on some Inspector models) allows you to use the Inspector with an external probe.

3 Operation

Units of Measurement

The Inspector is designed for use of conventional units (milliroentgens per hour and counts per minute) or SI units (microsieverts per hour and counts per second). To switch between conventional or SI units choose Option 2 in the Utility Menu. For details, see “Utility Menu” in Chapter 3.

Starting the Inspector

Before starting the Inspector, install a standard 9-volt alkaline battery in the battery compartment in the lower rear. Note: Place the battery against the bottom wall and make sure the wires are placed along the side of the battery and not under it.

Make sure the Timer switch on the end panel is turned off.

Start Up. To start the Inspector, set the top switch to the mode you want, and set the bottom switch to **On** or **Audio**. The Inspector then begins a six-second system check. All indicators and numbers are displayed.

After the system check, the radiation level is displayed in the selected mode. Thirty seconds after you start the Inspector, a short beep indicates that enough information has been collected to ensure statistical validity.

Display update. In the dose rate modes, the numeric display is updated every three seconds. In Total/Timer mode, the numeric display is updated twice a second.

Maximum level. When the maximum level for the current mode is reached, the Inspector beeps for three seconds, pauses for three seconds, and repeats that pattern. The numeric display flashes. The beeping pattern and the flashing display continue until the level decreases or the Inspector is turned off.

Response Time (Autoaveraging). When the radiation level is less than 6,000 CPM, the reading in any of the dose rate modes is based on the radiation detected in the immediately previous 30 seconds. In order to give a quicker response to changes, when the radiation level exceeds 6,000 CPM in any 30 second period, the reading is based on the previous 6 seconds. When the radiation level exceeds 12,000 CPM in any 30-second period, the reading is based on the previous 3 seconds. Note: You can choose the 3 second response at any radiation level by using the Utility Menu detailed in Chapter 3. Refer to the following table.

After 30 second start-up if instrument is detecting	the reading will be based on an average of the previous
(<100 CPS) < 6000 CPM or <1.75 mR/hr	30 seconds
(100 -200 CPS) 6000-12,000 CPM or 1.75-3.6 mR/hr	6 seconds
(>200 CPS) >12,000 CPM or >3.6 mR/hr	3 seconds fast response

Operating in Dose Rate Modes

Caution: 1. Be sure there is no obstruction between the detector window and source being monitored/surveyed. 2. Avoid making measurements with the GM window facing the sun, it could affect your readings.

When the mode switch is set to **mR/hr μSv/hr or CPM CPS**, the numeric display is updated every three seconds. At low count rates, significant changes in the radiation level displayed can take up to 30 seconds to stabilize. For details, see “Autoranging” in this chapter.

CPM (or CPS) and total counts are the most direct methods of measurement; mR/hr (or μSv/hr) is calculated using a conversion factor optimized for Cesium-137. This mode is less accurate for other radionuclides unless you have calibrated the Inspector for a similar radionuclide.

The most immediate indicators of the radiation level are the audio and count light. It takes 3 seconds before a change is shown on the numeric display unless you

are using the Total/Timer mode.

Operating in Total/Timer Mode

When the mode switch is set to **Total/Timer**, the numeric display is updated twice a second and totaling starts.

Taking a Timed Count

When a timed count is taken over a longer period, the average count per minute is more accurate, and any small increase is more significant. For example, if one 10-minute average is one count higher than another 10-minute average, the increase may be due to normal variation. But over 12 hours, a one-count increase over the 12-hour background average may be statistically significant.

Inspector can give you a total count for a timed period from 1 minute to 24 hours. For a timed count of less than one minute, watch the seconds countdown on the display. You can manually shut off the timer at any point.

Follow these steps to take a timed count:

1. With the Inspector operating, set the Mode switch to **Total/Timer**. The display shows **TOTAL**.
2. Set the Timer switch on the end panel to **Set**. The display shows **SET**, the hourglass, and the most recent timing period used. The first time you use the timer, the setting is 00:01, which means one minute.
3. Use the + and - buttons to set the timing period. The timed period can be for 1 to 10 minutes in one-minute increments, for 10 to 50 minutes in ten-minute increments, or for 1 to 24 hours in one-hour increments.
4. Set the Timer switch to **On**. The Inspector beeps three times and starts counting. The hourglass icon flashes during the timed period.
If you want to see how many minutes remain, set the Timer switch to **Set**. The display counts down from the time setting in hours and minutes to zero. For example, if the display says 00:21, 21 minutes remain. During the timed period, you can switch back and forth between **Total/Timer** and the dose rate modes without interrupting the timed period. The hourglass indicator will show in any mode setting and will blink while the timer is totaling.
5. At the end of the timed period, the Inspector beeps three times, and repeats the beeping several times over fifteen seconds. The number displayed is the

total count.

6. Set the Timer switch to **Off** to return to normal operation.

To find the average counts per minute for the timed period, divide the total by the number of minutes.

Using Dose Rate Modes While Timer is On

Dose rate modes can be used while the timer is on. In any dose rate mode, the hour glass indicator will continue to flash during a timed period. At the end of the timed period, the hour glass will remain continuously on and the timed reading is held in the Total/ Timer mode.

Taking a Total Count

The timer can take timed counts of up to twenty-four hours. In certain situations, you may want to take a total count without the timer; for example, taking a count for longer than twenty-four hours. Follow these steps:

1. Place the Inspector in the location where you plan to take the count.
2. Note the time.
3. Immediately when you note the time, set the mode switch to **Total/Timer**.
4. At the end of the time period, note the time and the number of counts on the numeric display.
5. Subtract the starting time from the ending time to determine the exact number of minutes in the timing period.
6. To get the average count, divide the total counts by the number of minutes in the timing period.

Autoranging

When radiation levels increases in some modes over certain preset levels, the Inspector uses autoranging, automatically changing to the **X1000** scale.

Whenever X1000 is shown above the numeric display, multiply the displayed reading by 1000 to determine the radiation level.

Mode	Ranges as they are displayed	
CPM	0 to 2,999 CPM	> 2,999 X1000 3.000 (3,000) CPM to 300 (300,000) CPM
Total/Timer	0-9,999 counts	> 9,999 X1000 10.00 (10,000) to 9999 (9,999,000) counts

Utility Menu

The Utility Menu allows the user to change default settings for several operating parameters. All settings remains in effect unless they are changed through the Utility Menu.

To activate the Utility Menu, hold down the + button while turning the instrument on. The display will show a single number on the numeric display indicating one of the options listed below. Scroll through the Menu by pushing the plus + or minus - buttons. To select an option, push the CAL button. Once you have selected an option, use the + or - buttons to toggle between choices. After making your choice, push the CAL button to enter the new setting and resume normal operation.

Options	Function	Comments
1. Auto Averaging or 3 sec. Averaging	“on” selects Auto Averaging “oFF” selects 3 second (fast response) averaging	Refer to “Response Time (Autoaveraging)” in Chapter 3
2. Units Of Measurements	Selects between mR/hr and CPM or μ Sv and CPS	
3. Cal 100 Reset	Automatically resets Cal factor to 100	No toggling required
4, 5, and 6.	Reserved for future options	
7. Cal Factor Adjust	Current Cal factor displayed. Adjust to the desired CAL Factor	Refer to “Calibration” in Chapter 5

Options	Function	Comments
8. Factory Default Reset	Automatically resets to Auto Averaging, mR/hr,	No toggling required and CAL 100
9. Revision #	Current version of programmed microprocessor	

Interfacing to an External Device

The lower output jack on the left side of the Inspector is a dual miniature jack that provides a data output that can be used to drive a CMOS or TTL device. You can use it to record the counts on a computer, data logger, or accumulating counter. The output at the tip of the plug provides a positive (5 volt) pulse each time the Geiger tube detects a count.

Options

WipeTest Plate (patent # 5,936,246)

The stainless steel WipeTest Plate has a circular depression for placement of a wipe parallel to the detector window at a fixed distance of 1 cm. The WipeTest Plate is designed to slide easily onto the back of the Inspector.

4 Common Procedures

The following sections give instructions for several commonly-used procedures. With any procedure, the user must determine the suitability of the instrument or procedure for that application.

Establishing the Background Count

Normal background radiation levels vary at different locations, time, even in different areas of the same room. To accurately interpret the readings you get on the Inspector, it is a good idea to establish the normal background radiation count rate for each area you plan to monitor. You can do this with a timed count. Use the following steps to get a ten-minute average.

1. With the Inspector operating, set the Mode switch to **Total/Timer**.
2. Set the Timer switch on the end panel to **Set**. The display should read 00:01, which means one minute.
3. Press the + button nine times. The display should read 00:10, for ten

minutes.

4. Set the Timer switch to **On**. The Inspector beeps three times and starts counting.

If you want to see how much of the ten minutes remains, set the Timer switch to **Set**. The display counts down from ten minutes to zero. For example, if the display says 00:03, seven minutes have passed and three minutes remain.

5. At the end of the ten minutes, the Inspector beeps three times, and repeats the beeping several times over fifteen seconds.

A ten-minute average is moderately accurate. You can repeat it several times and see how close the averages are. To establish a more accurate average, take a one-hour timed count. If you need to determine whether there is prior contamination, take averages in several locations and compare the averages.

For more information on using the timer, see "Taking a Timed Count" in Chapter 3.

Environmental Area Monitoring

You can keep the Inspector in CPM or mR/hr mode whenever you want to monitor the ambient radiation, and look at it from time to time to check for elevated readings.

If you suspect an increase in ambient radiation, use the timer and take a five or ten minute count, and compare the average to your average background count. If you suspect an increase that is too small to detect with a short timed reading, you can take a longer count (for example 6, 12, or 24 hours).

Checking for Surface Contamination

CAUTION: *Never touch the Inspector to a surface that may be contaminated. You may contaminate the instrument. The rubber strips on the back can be replaced if they become contaminated. Replacement strips are supplied in this manual.*

To check a surface, hold the Inspector with the window facing close to the surface and read the count rate (wait 30 seconds or until the reading has stabilized). If you want to find out if a surface is slightly radioactive, place the Inspector next to it and take a timed count or a longer accumulated count.

5 Maintenance

The Inspector requires regular calibration and careful handling to assure good measurements. Use the following guidelines to maintain the Inspector properly.

Calibration

The Inspector should be calibrated as often as your regulations require, or in any case, at least once a year. The best way to calibrate is using a calibrated source. If no source is available, it is possible to calibrate electronically using a pulse generator.

The standard radionuclide for calibration is Cesium-137. A certified calibration source should be used. To calibrate the Inspector for another radionuclide, you must use a calibrated source for that radionuclide or the appropriate conversion factor referenced to Cs-137.

CAUTION: *Errors can occur when using low level sources or background to set CAL factor. In the Calibration mode, the smallest increment which can be adjusted is .010, which prevents fine adjustment of the CAL factor.*

Calibrating Using a Source

1. Place the Inspector or Inspector EXP probe at a distance from the source that corresponds to a 50 mR/hr field with the detector window facing the source.
2. Set the Inspector mode switch to mR/hr.
3. Turn the Inspector on.
4. Open the source and record 20 consecutive readings.
5. Close the source.
6. Calculate the average of the readings and record.
 - a) If the average is $\pm 10\%$ of 50 mR/hr, go to Step 7.
 - b) If the average is not $\pm 10\%$ of 50 mR/hr, go to Step 10.
7. Place the Inspector or the Inspector EXP probe at a distance from the source that corresponds to a 5 mR/hr field with the detector window facing the source.
8. Repeat Steps 2 - 4.
9. Calculate the average of the readings and record.

- a) If the average is $\pm 10\%$ of 5 mR/hr, the calibration procedure is complete.
 - b) If the average is not $\pm 10\%$ of 5 mR/hr, go to Step 10.
10. Turn off the AUDIO in order to hear the count down timer sound.
 11. Press the CAL button on the top of Inspector. The display shows CAL, and the Inspector counts down for 15 seconds, chirping each second. This delay gives you a chance to move out of the field and then expose the source. At the end of the 15 seconds, the Inspector beeps.
 12. The Inspector collects data for 30 seconds, chirping every 2 seconds, with CAL and the hourglass icon flashing. At the end of the 30 seconds, it beeps. The display shows CAL and SET is flashing.
 13. Close the source.
 14. Press the + and - buttons on the Inspector to adjust the reading to what it should be.
 15. When the reading is correct, press the CAL button. The new calibration factor is displayed for several seconds, then the Inspector beeps and resumes normal operation.
 16. Record the new calibration factor.
 17. Place the Inspector or the Inspector EXP probe at a distance from the source that corresponds to a 5 mR/hr field with the detector window facing the source.
 18. Repeat Steps 2 - 4.
 19. Calculate the average of the readings and record.]
 - a) If the average is $\pm 10\%$ of 5 mR/hr, the calibration procedure is complete.
 - b) If the average is not $\pm 10\%$ of 5 mR/hr, repeat steps 11 - 16 and go to step 20.
 20. Calculate the average of the calibration factor for 50 mR/hr and the calibration factor for 5 mR/hr.
 21. Turn the Inspector off.
 22. Hold down the + button while turning the Inspector on. The numeric display will show a single number.
 23. Press the + or - button until 7 is shown on the numeric display.
 24. Push the Cal button.
 25. The calibration factor is displayed. Press the + or - buttons to adjust the

calibration factor to the average calibration factor calculated in Step 20.

26. Push the CAL button to enter the new setting and resume normal operation.

The calibration factor is set to 100 (percent) at the factory. If you change the reading, for example, to 20% higher than the factory reading, the new calibration factor would be 120. The current calibration factor is displayed during the system check when the Inspector is first turned on.

Pre-Calibrating Electronically

You can calibrate electronically using a pulse or function generator. Electronic calibration requires a cable with a 2.5 mm plug, with the tip carrying the signal. Follow these steps:

1. Set the signal height to 5 volts and a negative pulse width of 75 microseconds.

CAUTION: Do not inject a pulse when the Inspector is turned off.
Do not exceed 5 volts.

2. Turn on the Inspector and set the mode switch to mR/hr μ Sv/hr .
3. Plug the cable into the upper jack.
4. Use the following table to check the Inspector's accuracy. The table shows appropriate pulse generator count rates to calibrate for Cs-137. If the accuracy is not within desired limits, follow steps 5-7. Note that the Inspector automatically compensates for lost counts due to GM tube dead time. Thus, the display reading in CPM mode will not equal the input frequency. You can display uncompensated counts in the CPM mode by continuously holding down the "-" button. The reading will now correspond to the input frequency.

Pulse Generator Input (PPM)	CPM	mR/Hr	μ Sv/hr	CPS
30,683	32,240	10	100	537
56,886	64,480	20	200	1,075
111,059	161,201	50	500	2,687
145,518	257,920	80	800	4,299
160,546	over range	100	1,000	over range

5. Press the CAL button on the top of Inspector.

The display shows **CAL**, and the Inspector counts down for 15 seconds, chirping each second. At the end of the 15 seconds, the Inspector beeps.

6. The Inspector collects data for 30 seconds, chirping every 2 seconds, with **CAL** and the hourglass icon flashing. At the end of the 30 seconds, it beeps. The display shows **CAL**, and **SET** is flashing
7. Press the + and - buttons to adjust the reading to what it should be. When the reading is correct, press the CAL button.

The new calibration factor is displayed for several seconds, then the Inspector beeps and resumes regular operation.

Troubleshooting

The Inspector is a highly reliable instrument. If it does not seem to be working properly, look through the following chart to see if you can identify the problem.

Problem	Possible Cause	What To Check
Display is blank	no battery, dead battery, poor battery connection defective LCD	install a new 9-volt battery if count light and audio work, the LCD may need to be replaced
Display works, but no counts are registered	defective Geiger tube or bad cable	look through the window to check the mica surface of the tube; if it is wrinkled or a break is visible, replace it check cable connection
Reading is high, but another instrument has a normal reading in the same location	contamination	check the Inspector with another instrument; replace rubber strips on back of instrument
Instrument has false high reading	moisture	circuit board may be wet; dry the instrument in a warm dry place; if it still has a problem, it requires factory service

Problem	Possible Cause	What To Check
Instrument has false high reading	photosensitivity	remove from direct sunlight and ultraviolet sources; if the high count drops, the mica window coating may have washed off the Geiger tube due to getting wet; the tube will need to be replaced
Instrument has false high reading	continuous discharge	replace the Geiger tube
Instrument has false high reading	electromagnetic field	move the instrument away from possible sources of electromagnetic or radio frequency radiation

Service

CAUTION: *Do not send a contaminated instrument for repair or calibration under any circumstances. There are no servicable parts inside instrument.*

If the Inspector requires servicing, please contact your distributor or the manufacturer at the following address:

S.E. International, Inc.
P.O. Box 39, 436 Farm Rd.
Summertown, TN USA 38483-0039
Tel 931-964-3561, Fax 931-964-3564
E-mail: seiinc@usit.net

6 Basics of Radiation and Its Measurement

This chapter briefly tells what radiation is and how it is measured. This information is provided for users who are not already familiar with the subject. It is helpful in understanding how the Inspector works and in interpreting your readings.

Ionizing Radiation

Ionizing radiation is radiation that changes the structure of individual atoms by ionizing them. The ions produced in turn ionize more atoms. Substances that produce ionizing radiation are called radioactive.

Radioactivity is a natural phenomenon. Nuclear reactions take place continuously on the sun and all other stars. The emitted radiation travels through space, and a small fraction reaches the Earth. Natural sources of ionizing radiation also exist in people and in the ground. The most common of these are uranium and its decay products.

Ionizing radiation is categorized into four types:

X-rays are manmade radiation produced by bombarding a metallic target with electrons at a high speed in a vacuum. X-rays are electromagnetic radiation of the same nature as light waves and radio waves, but at extremely short wavelength, less than 0.1 billionth of a centimeter. They are also called photons. The energy of X-rays is millions of times greater than that of light and radio waves. Because of this high energy level, X-rays penetrate a variety of materials, including body tissue.

Gamma rays are almost identical to X-rays. Gamma rays generally have a shorter wavelength than X-rays. Gamma rays are very penetrating; thick lead shielding is generally required to stop them.

Beta radiation A beta particle consists of an electron emitted from an atom. It has more mass and less energy than a gamma ray, so it doesn't penetrate matter as deeply as gamma and X-rays.

Alpha radiation An alpha particle consists of two protons and two neutrons, the same as the nucleus of a helium atom. It generally can travel no more than 1 to 3 inches in air before stopping, and can be stopped by a piece of paper.

When an atom emits an alpha or beta particle or a gamma ray, it becomes a different type of atom. Radioactive substances may go through several stages of decay before they change into a stable, or non-ionizing, form.

An element may have several forms, or isotopes. A radioactive isotope of an element may be called "radioisotope". However, the more correct term is

radionuclide. Each radionuclide has a characteristic half-life, which is the time required for half of a quantity of the material to decay.

The following chart shows the complete decay chain for Uranium 238, which ends with a stable isotope of lead. Notice that the half-life of the radionuclide in the chain range from 164 microseconds to 4.5 billion years.

Isotope	Emits	Half-life	Product
U-238	alpha	4.5 billion years	Th-234 Thorium
Th-234	beta	24.1 days	Pa-234 Proactinium
Pa-234	beta	1.17 minutes	U-234 Uranium
U-234	alpha	250,000 years	Th-230 Thorium
Th-230	alpha	80,000 years	Ra-226 Radium
Ra-226	alpha	1,602 years	Rn-222 Radon
Rn-222	alpha	3.8 days	Po-218 Polonium
Po-218	alpha	3 minutes	Pb-214 Lead
Pb-214	beta	26.8 minutes	Bi-214 Bismuth
Bi-214	beta	19.7 minutes	Po-214 Polonium
Po-214	alpha	164 microseconds	Pb-210 Lead
Pb-210	beta	21 years	Bi-210 Bismuth
Bi-210	beta	5 days	Po-210 Polonium
Po-210	alpha	138 days	Pb-206 Lead

Radiation Measurement Units

Several different units are used to measure radiation, exposure to it and dosage.

A **roentgen** is the amount of X-radiation or gamma radiation that produces one electrostatic unit of charge in one cc of dry air at 0° C and 760 mm of mercury atmospheric pressure. The Inspector displays in milliroentgens per hour (mR/hr).

A **rad** is the unit of exposure to ionizing radiation equal to an energy of 100 ergs per gram of irradiated material. This is approximately equal to 1.07 roentgen.

A **rem** is the dosage received from exposure to a rad. It is the number of rads multiplied by the quality factor of the particular source of radiation. The rem and millirem are the most commonly-used measurement units of radiation dose in the U.S. 1 rem= 1rad.

A **sievert** is the standard international measurement of dose. One sievert is equivalent to one hundred rems. A microsievert (μSv) is one millionth of a sievert.

A **curie** is the amount of radioactive material that decays at the rate of 37 billion disintegrations per second, approximately the decay rate of one gram of radium. Microcuries (millionths of a curie) and picocuries (trillionths of a curie) are also often used as units of measurement.

A **becquerel (Bq)** is equivalent to one disintegration per second.

Appendix A - Technical Specifications

Detector:	Internal	Halogen-quenched Geiger-Mueller tube. Effective dia. 1.75" (45 mm). Mica window density 1.5-2.0 mg/cm ² .
	External RAP-RS1	Same detector as Built-in. Anodized aluminum housing with black vinyl grip. 500 volt power supply is located in the probe head. Connectors: Amphenol 31226 twinax.
Display:		4-Digit liquid crystal display including mode indicators
Operating Range:		mR/hr: .001 to 100.0 CPM: 0 to 300,000 Total: 1 to 9,999,000 counts $\mu\text{Sv/hr}$: .01 to 1,000 CPS: 0 to 5,000
Efficiency:		Sr(Y)-90: approx. 38%; C-14: approx. 5.3%
4 π at contact		P-32: approx 33%; Co-57: approx. .3%

Gamma Sensitivity:
3500 CPM/mR/hr
referenced to Cs-137
Smallest detectable level
for I-125 is .02 μCi
at contact

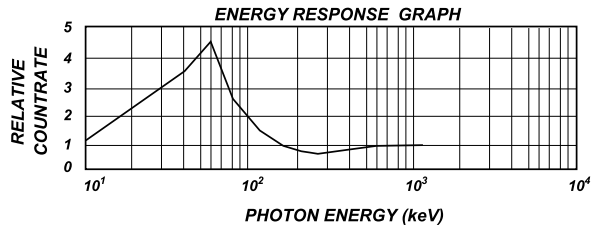

Averaging Periods:	Display updates every 3 seconds, showing the average for the past 30-second time period at normal levels. The averaging period decreases as the radiation level increases. Refer to Chapter 3 Operation- Autoranging, Display update.
CAL Factor Range:	001 to 199
Timer:	Can set 1-10 minute sampling periods in one minute increments, 10-50 minute sampling periods in 10-minute increments, and 1-24 hour sampling periods in 1-hour increments
Accuracy:	mR/hr: $\pm 15\%$ up to 50 mR/hr $\pm 20\%$ up to 100 mR/hr CPM: $\pm 15\%$ up to 130,000 CPM $\pm 20\%$ from 130,000 to 300,000 CPM
Beeper:	Operational in Audio mode only
Anti-Saturation:	Readout holds at full scale in fields up to 100 times the maximum reading.
Temperature Range:	-10° to +50° C , 14° to 122° F
Power:	One 9-volt alkaline battery. Battery life is minimum 200 hrs at normal background. Minimum 24 hrs at 1 mR/hr.
Size:	150 x 80 x 30 mm (5.9" x 3.2" x 1.2")
Weight:	272 grams (9.6 oz) including battery

Appendix B Sensitivity to Common Isotopes

Typical GM tube efficiency for 4 Pi geometry at contact

Isotope	E max. MeV	Efficiency
Beta		
¹⁴ C	49 keV Avg. 156 keV Max.	5.3%
²¹⁰ Bi	390 keV Avg. 1.2 MeV Max.	32%
⁹⁰ Sr(Y)	546 keV and 2.3 MeV	38%
³² P	693 keV Avg. 1.7 MeV max.	33%

Appendix C - Inspector EXP Carrying Case

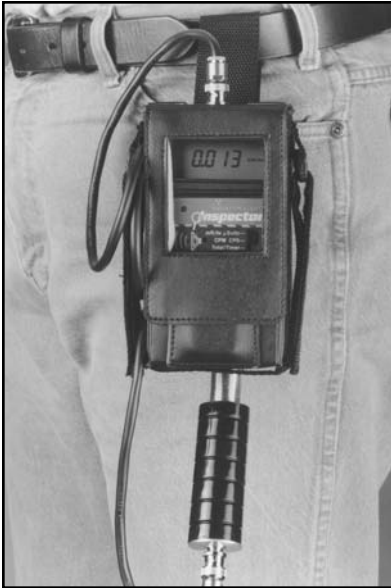

The carrying case has a clear window panel providing full view of the readout, count light and access to the switches. Convenient hand straps and a belt loop are provided for carrying the instrument.



The reinforced protective probe cover prevents damage to the fragile window of the detector.

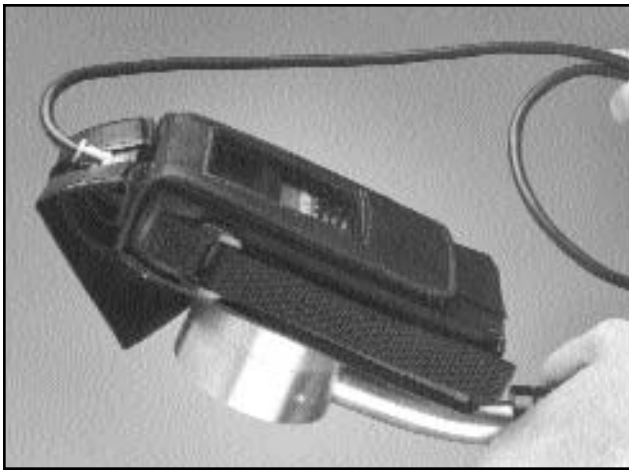

The unique design of attaching the probe to the carrying case allows one handed operation if desired. The probe cover folds easily out of the way during one handed operation.

The front flap lifts out of the way to gain access to switches and a small pocket is provided to hold a check source. For the protection of the user, we recommend that you use a .1 microcurie Cesium 137 check source shielded on both sides. Gamma shields for this source are available through your distributor.



Warranty

LIMITED WARRANTY

WARRANTOR: S.E. International, Inc., P.O. Box 39, 436 Farm Road, Summertown, TN 38483-0039, USA, (931) 964-3561

ELEMENTS OF WARRANTY: S.E. International, Inc., warrants for 90 days the Geiger-Mueller tube and for one year all materials and craftsmanship in this product to be free from all defects with only the limitations set out below.

WARRANTY DURATION: The warranty shall terminate and be of no further effect one year (90 days on the GM tube) after the original date of purchase of the product or at the time the product is: a) damaged or not maintained as is reasonable or necessary, b) modified, c) repaired by someone other than the warrantor for a defect or malfunction covered by this Warranty, d) contaminated with radioactive materials, or e) used in a manner or purpose for which the instrument was not intended or contrary to S.E. International, Inc.'s written instructions. This warranty does not apply to any product subjected to corrosive elements, misuse, abuse, or neglect.

STATEMENT OF REMEDY: In the event that the product does not conform to the warranty at any time while this warranty is effective, the Warrantor will repair the defect and return the instrument to you prepaid, without charge for parts or labor.

NOTE: While the product will be remedied under this warranty without charge, this warranty does not cover or provide for the reimbursement or payment of incidental or consequential damages arising from the use of or the inability to use this product. The liability of the company arising out of the supplying of this instrument, or its use, whether on warranties or otherwise, shall not in any case exceed the cost of correcting defects in the instrument, and after the said one year (90 days on the tube) period all such liability shall terminate. Any implied warranty is limited to the duration of the written warranty.

PROCEDURE FOR OBTAINING PERFORMANCE OF WARRANTY: In the event that the product does not conform to this warranty, please write or call to the address above. S.E. International, Inc. will not accept contaminated instruments for calibration or repair under warranty or otherwise.

NOTE: Before using this instrument, the user must determine the suitability of the product for his or her intended use. The user assumes all risk and liability connected with such use.

----- Cut along dotted line -----
CALIBRATION DATABASE APPLICATION

name

company

address

City, state, zip code +4

phone number

model name

serial no.
(Inside battery compartment or rear label)

calibrations per year
(circle) 1 2 3 4

Mail to Attn: Steve Skinner or Robbin Cramer

S.E. International, Inc., P.O. Box 39, Summertown, TN 38483-0039 or fax to (931) 964-3564